

BEIJING HUADE HYDRAULIC INDUSTRIAL GROUP CO.,LTD.	Proportional Pressure Relief Valve Type DBETR			RC29166/9.2006
	Size 6	up to 31.5 MPa	up to 10 L/min	Replaces: RC29166/08.2000

Features:

- Low hysteresis
- Good repeatability
- Electrical closed loop position control of spring pre-tension,
- Proportional solenoid actuation with inductive position transducer (pressure balanced)
- Valve and electronic control from one source



Function, section, symbol

This valve regulates pressure in proportion to the electrical command value.

The valve consists basically of a housing (1), proportional solenoid (2) with inductive positional transducer (3), valve seat (4) and valve poppet (5).

Pressure is set by adjusting the command value potentiometer (0 to 9 V). Adjusting the command value causes tensioning of the compression spring via the electronic controls and the proportional solenoid (2). Tensioning of the compression spring (6), i.e. the position of the spring plate (7), is determined by the inductive positional transducer (3). Any deviations from the command value are corrected by the closed loop positional control.

The use of this principle eliminates the effect of solenoid friction.

- Advantages:**
- Low hysteresis
 - Good repeatability

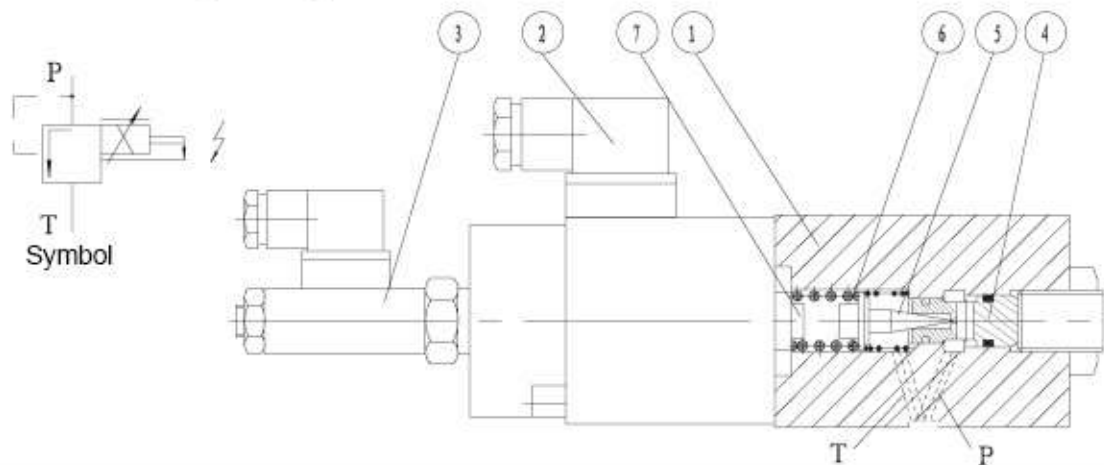

Ordering details

DBETR	- 10	B	/			*
Series 10 to 19 (10 to 19: unchanged installation and connection dimensions)	= 10					Further details in clear text
Technology of Beijing Huade Hydraulic	=B					M= mineral oils V = phosphate ester
Pressure stage: up to 2.5MPa up to 8MPa up to 18MPa up to 31.5MPa	=25 =80 =180 =315					No code= let oil inside Y= let oil outside

Technical data

Hydraulic data

Max. settable pressure (MPa)	Pressure stage 2.5 MPa	2.5			
	Pressure stage 8.0 MPa	8			
	Pressure stage 18.0 MPa	18			
	Pressure stage 31.5 MPa	31.5			
Min. settable pressure (MPa)	(see $p_{min} - q_v$ characteristic curves)				
Max. Operating pressure (MPa)	port T (with pressure adjusting)	0.2			
	por T (without pressure adjusting)	10			
	port P	31.5			
Max. flow (L/min)	Pressure stage 25	10			
	Pressure stage 80	3			
	Pressure stage 180	3			
	Pressure stage 315	2			
Degree of contamination (μm)	≤ 20 (recommendation 10)				
Hysteresis (%)	< 1 of max. settable pressure				
Repeatability (%)	< 0.5 of max. settable pressure				
Linearity (%)	180; Pressure stage from 3 to 18 MPa	≤ 1.5 of max. settable pressure			
	315; Pressure stage from 6 to 31.5MPa				
Typical variation (%)	Valve	± 3 of max. settable pressure			
	Electrical control	< 0.5			
Stepped response 0 to 100%	(ms)	Response time (Pmin-Pmax)	Response time (Pmax-Pmin)		
		Pressure stage 2.5 and 18MPa	0 to 100	100	50
		Pressure stage 31.5MPa	0 to 100	150	100
Pressure fluid	Mineral oil (for NBR seal), Phosphate ester (for FPM seal)				
Viscosity range (mm^2/s)	2.8 to 380				
Pressure fluid temperature range ($^{\circ}C$)	-20 to +70				
Installation position	optional				
Weight (kg)	4				

Electrical

Amplifier associated	VT-5003S30		
Supply voltage	DC		
Coil resistance (Ω)	Cold value at 20 $^{\circ}C$	10	
	Max. warm value	13.9	
(Working state) Duty	Continuous		
Pressure fluid temperature ($^{\circ}C$)	+50		
Amplifier voltage	commutate completely	24 \pm 10%	
	commute three electrical source	24 to 35	
Max. power consumption (VA)	50		
Coil resistance at 20 $^{\circ}C$ (Ω)	1	11	111
	56	56	112
Inductivity (transducer) (mH)	6 to 8		
Oscillator frequency (transducer) (KHz)	2.5		
Protection to DIN 40 050	IP65		

Characteristic curves:(measured at $v=36 \times 10^{-6}m^2/S$ $t=50^{\circ}C$)

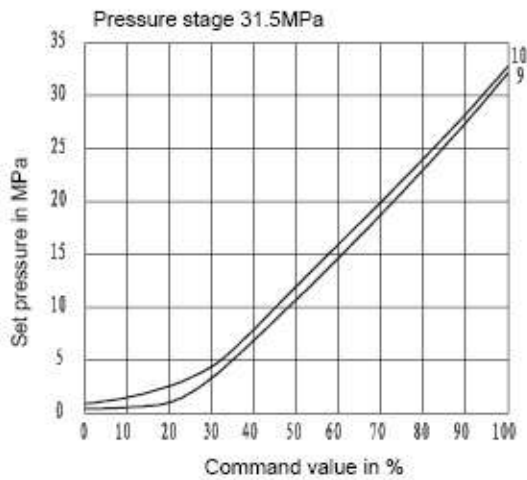
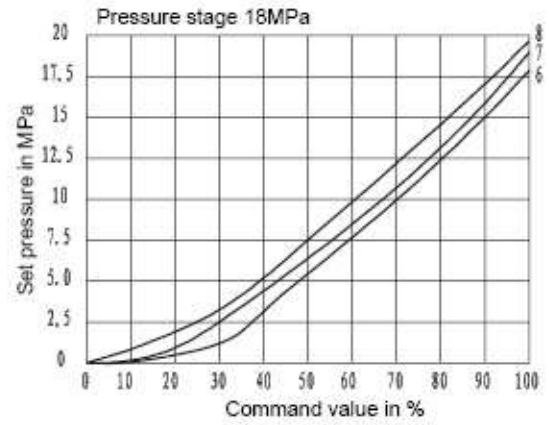
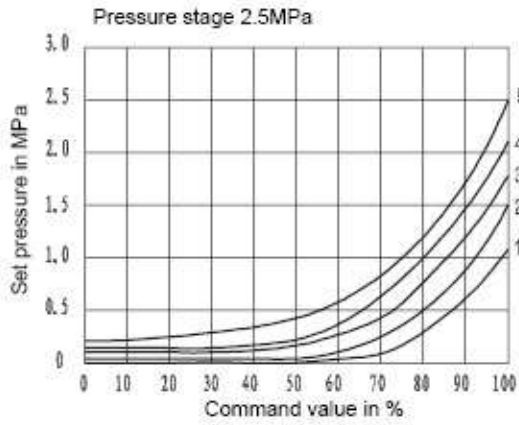

- Curve 1 - flow = 2 L/min
- Curve 2 - flow = 4 L/min
- Curve 3 - flow = 6 L/min
- Curve 4 - flow = 8 L/min
- Curve 5 - flow = 10 L/min
- Curve 6 - flow = 0.5 L/min
- Curve 7 - flow = 1.5 L/min
- Curve 8 - flow = 3L/min
- Curve 9 - flow = 1 L/min
- Curve 10 - flow = 2 L/min

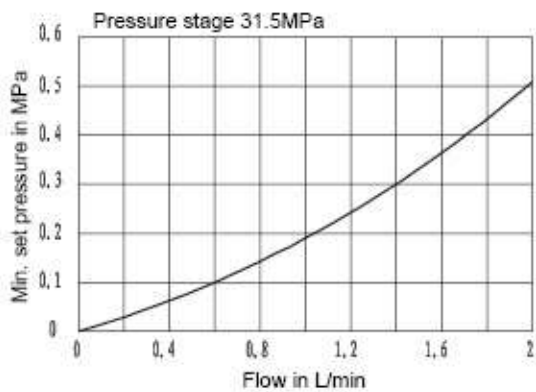
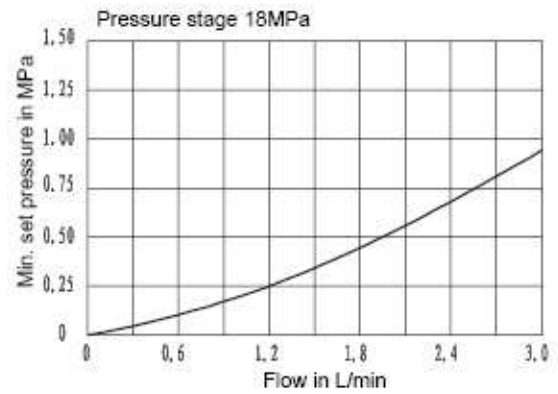
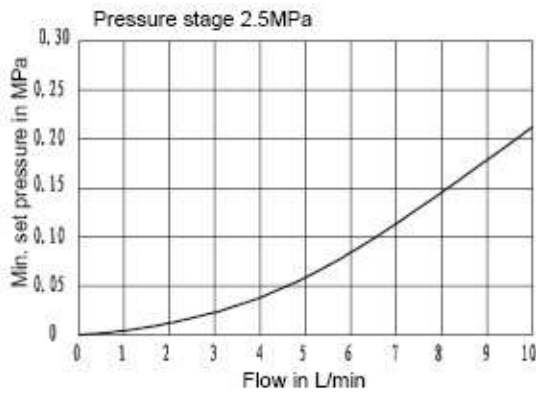

Electrical connections (Inductive position transducer)

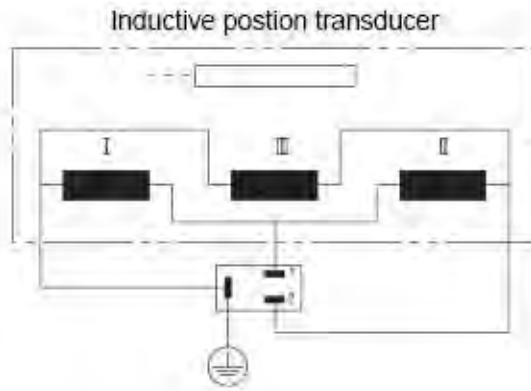

Type Connection of plug-in connector

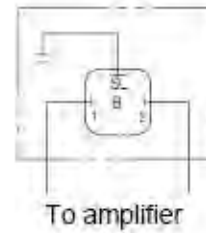

Unit dimensions

(Dimensions in mm)

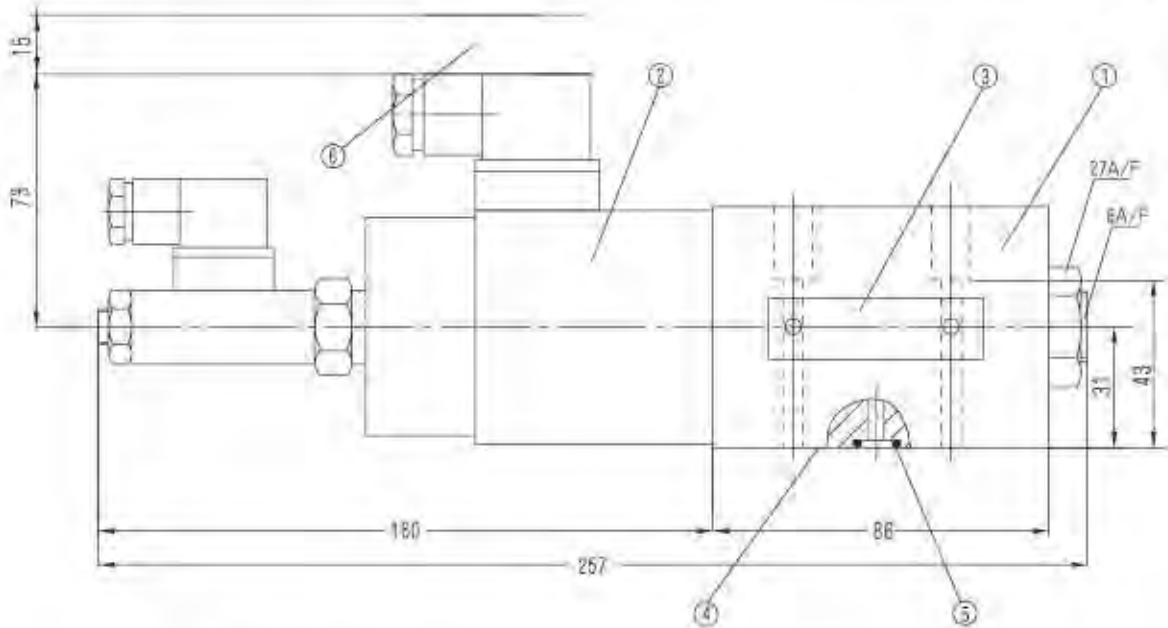

Type DBETR

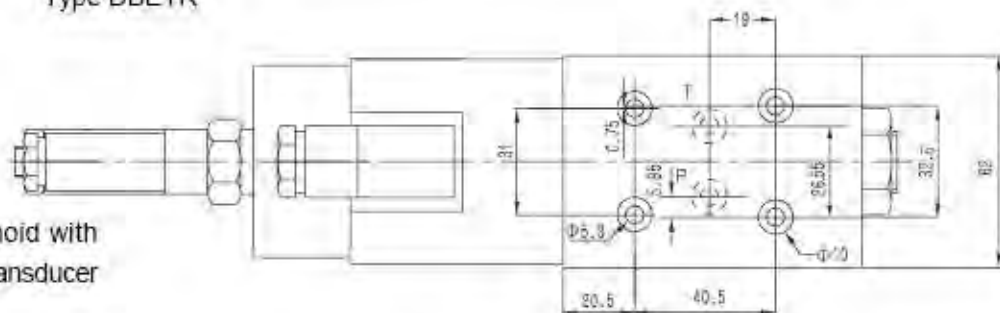

- 1 Valve housing
- 2 Proportional solenoid with inductive position transducer
- 3 Nameplate
- 4 Machined valve mounting surface
- 5 O-ring 9.25 x 1.78
- 6 Space required to remove the plug-in connector

Type DBETR...Y

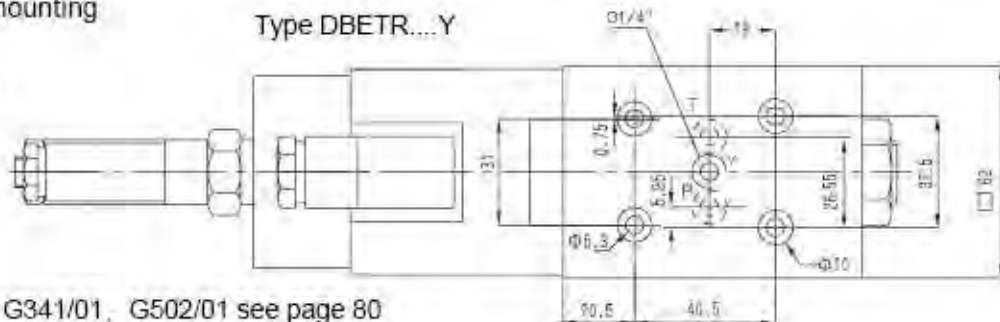

Subplates: G340/01, G341/01, G502/01 see page 80